

「Full Screen」 NO RESIDUE OF WATER & DUST
user
MANUAL

– Reinvents the PV Module –

ELECTRICAL INSTALLATION

SERIES CONNECTION

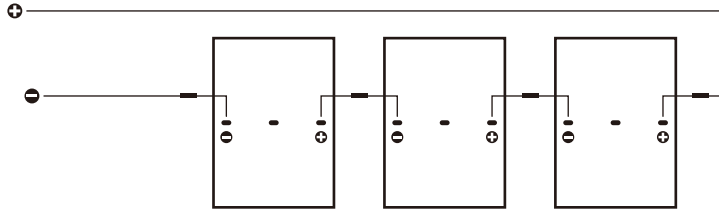

PARALLEL AFTER SERIES

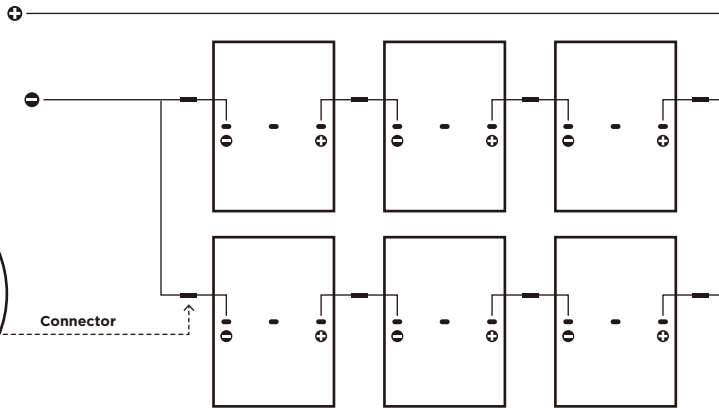

* Electrical performance parameter of module, such as nominal value of I_{sc} , V_{oc} and P_{max} has $\pm 3\%$ random error compared with value of STC. The standard testing environment of module is: Irradiance $1000/m^2$, Cell temperature $25^{\circ}C$, Spectrum AM 1.5.

* Normally, the current and voltage of module, will be a little higher compared with the value under STC, so when confirmed the associated parameters of solar system accessories, such as rated voltage, cable capacity, fuse capacity and module power, the corresponding short circuit current and open circuit voltage should be amplified by 1.25 times.

* The maximum number of modules per series string must be calculated according to the requirements. The value of the V_{oc} in the local expected minimum temperature cannot exceed the maximum system voltage value specified of the module (According to IEC61730 safety test, the maximum system voltage of DAHUA Solar Module is DC1000V) and other DC electrical components require values.

* The V_{oc} correction factor can be calculated according to the following formula: $C_{Voc} = 1 - \beta(V_{oc} \times (25 - T))$, T is the minimum ambient temperature expected for the installation of the system, β (% / $^{\circ}C$) is The temperature coefficient of the selected module V_{oc} (according to the corresponding module data sheet).

* If the reverse current which probably exceed the maximum fuses current of module passed through the module, the modules must be protected by an equivalent current protection device. If the number of parallel is more than or equal to 2 strings, there must be equipped an overcurrent protection device on each series of modules.

WARNING

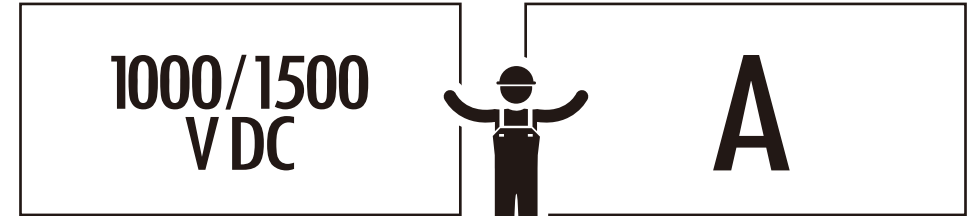

The maximum permitted system voltage (DC) of the modules is 1000V DC (Option 1500V DC)

PV module application class is A

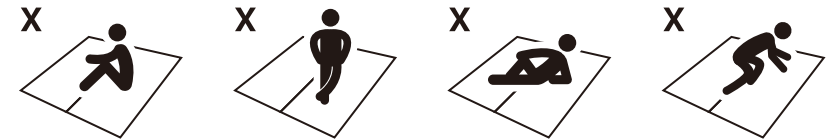

* When Module exposed to sunshine or other lights, it can produce DC, in this case it may cause electric shock hazard if touch electrical parts.

* Focus sunlight on to PV module via mirror or lenses is prohibited.

* Temples glass and backsheet have protective effect, broken PV modules have electrical risks (electric shock and burnt), this kind of modules can not be fixed or repaired, should be replaced in time.

* Under nominal outdoor condition, the current and voltage produced by module are different with datasheet. The parameters in datasheet is tested under STC condition, therefore when determining other components rated voltage, wire capacity, fuse rate, controller capacity and PV module power output relative datas of PV system, please refer to the short circuit current and open circuit voltage of the PV module, and design and install the system in 125% of the value as well.

* In case to lower electric shock or burnt risk, it's better to cover the PV modules by opaque material when installing.

* PV array installation job should be operated under isolating sunlight condition, installation and maintenance also should be handled by professionals.

* If batteries bank equipped in the PV system, it should comply with battery supplier's suggestion.

* PV modules shall not replace rooftop and wall material, partial replacement is also not allowed.

* Don't install PV modules in the area where may has combustible gases.

* Touch PV module's electrical part by hand directly is prohibited, should use insulating tools to handle the electrical connecting.

* Don't dismantle any components of DAHUA Solar PV module personally.

* Don't lift modules by junction box or connecting cables.

* All the modules system should be connected to ground, if without special stipulations, please refer to International Electrical Standard or other International Standards.

* Please do not stand, sit, lying on modules, it may damage modules and also have injured risks.

* Same size and specification models modules can only be connected together.

* During delivery please make sure transport tools or modules are not subjected to large vibrations, vibrations may cause modules damage or cells microcrack inside of modules.

* During all the delivery, don not allow modules to fall onto ground from transport tools, house or hand, this will damage modules or cells inside.

* Don't wipe the module with corrosive chemicals.

* When loads are working, please do not disconnect the modules.

Please

read

the manual

carefully



“ Please remember that you are using a electricity generation product, in order to avoid any accident, it should adopt relative security measures. ”





THANKS FOR CHOOSING SOLAR

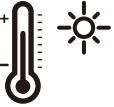

Installation Safety

- Please wear protective headcoats, insulated gloves, and rubber insulated shoes during installation job.
- To avoid unnecessary touching of the PV module during installation. The surface of modules may over heated, it has risk of burnt and electric shock.
- Due to the risk of electric shock, please do not proceed the installation work if junction box was wet.
- Use insulated and dry tools, do not use wet tools.
- Don't use sharp tools to wipe the glass of PV module. It would leave scratches on the module.

Climatic Condition

 <p>+40°C ~ 85°C (-4°F ~ 185°F) Ambient temperature</p>		 <p>Don't install PV modules in a flooded risk area</p>		 <p>Don't install in raining, snowing or windy weather conditions</p>
--	---	--	---	--

Angle Selection

The PV modules should be installed in the place with the maximum sunlight throughout the year. The output power will be maximum when modules are facing the sun in vertical. In the northern hemisphere, modules should be placed toward south as the first choice, while in the southern hemisphere, it should be placed toward north.

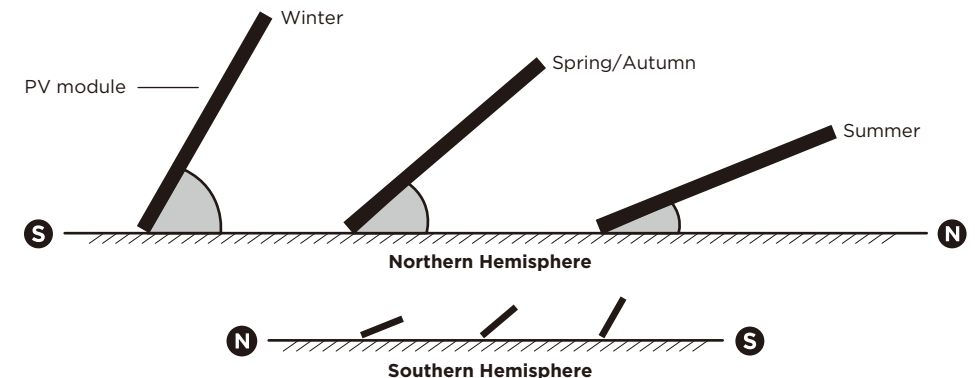

INSTRUCTION OF INSTALLATION METHODS

SCREWS INSTALLING METHOD

Modules can be attached through the mounting holes on the back frame of the module, by fixing the module to the support rails with bolts. The mounting details are shown in the following figures.

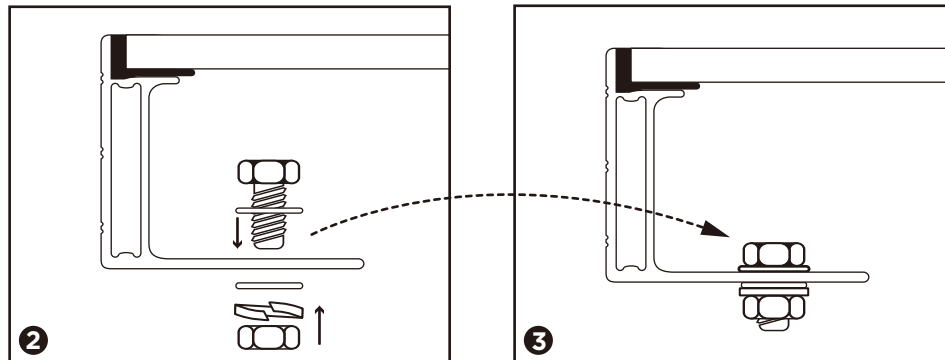
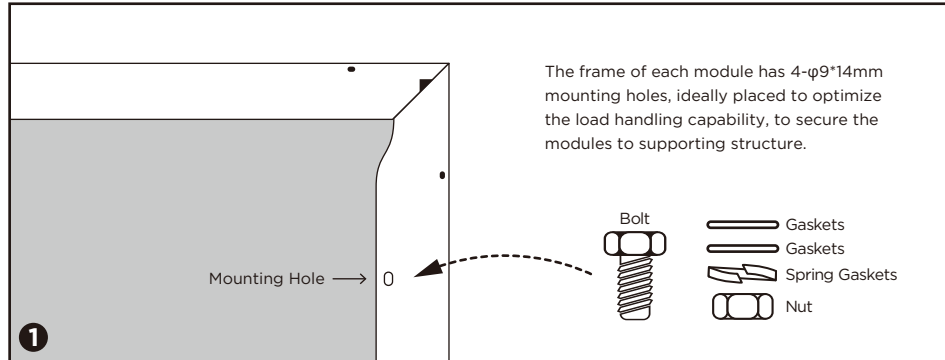

Secure the module in each mounting location with an M8 bolt and a flat washer, spring washer and nut as shown in Figure 1 and tighten to a torque of 16-20 N.m(140-180lbf.in.). All parts in contact with the frame should use flat stainless steel washers of minimum 1.8mm thickness with an outer diameter of 20-24mm (0.79-0.94in).

CLAMPS MOUNTING METHOD

The clamp must overlap the module frame by at least 7mm (0.28in) but no more than 10mm (0.39in).

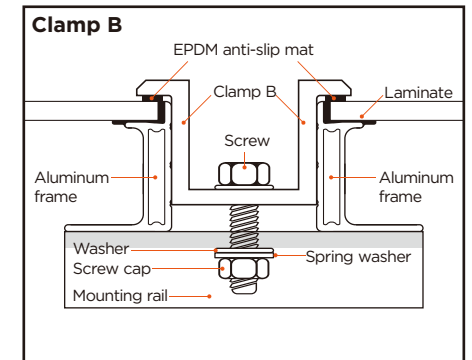
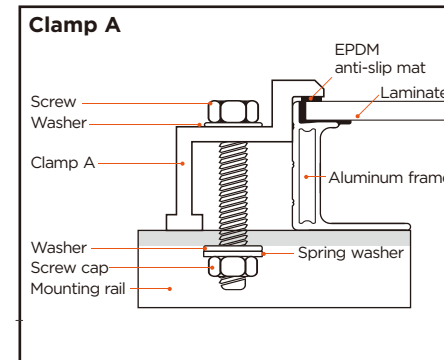
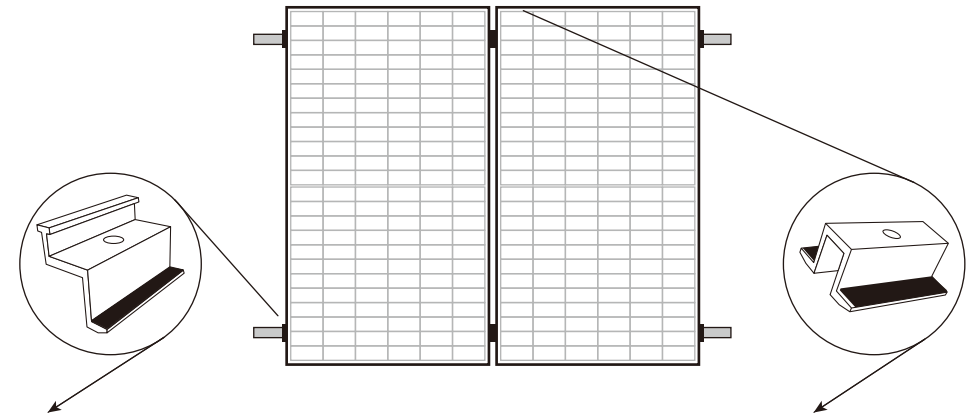

When choosing this type of clamp-mounting method, use at least four clamps on each module, two clamps should be attached on each long sides of the module (for portrait orientation) or each short sides of the module (for landscape orientation). Depending on local wind and snow loads, additional clamps may be required to ensure that modules can bear the load.



NOTES

All mentioned clamp mounting methods here are only for reference, DAHUA Solar will not be responsible for the system design and installation. The mechanical loads and its safety must be operated and completed by the professional solar system installer and experienced installation team.